

MaxMotion

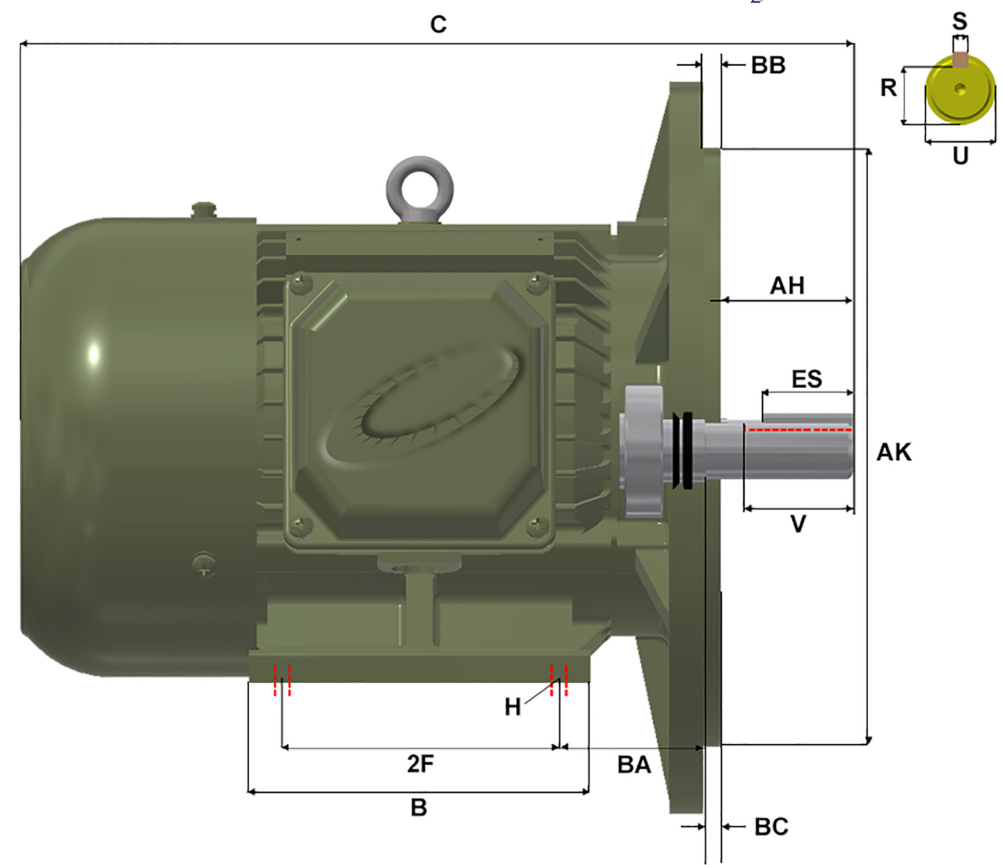
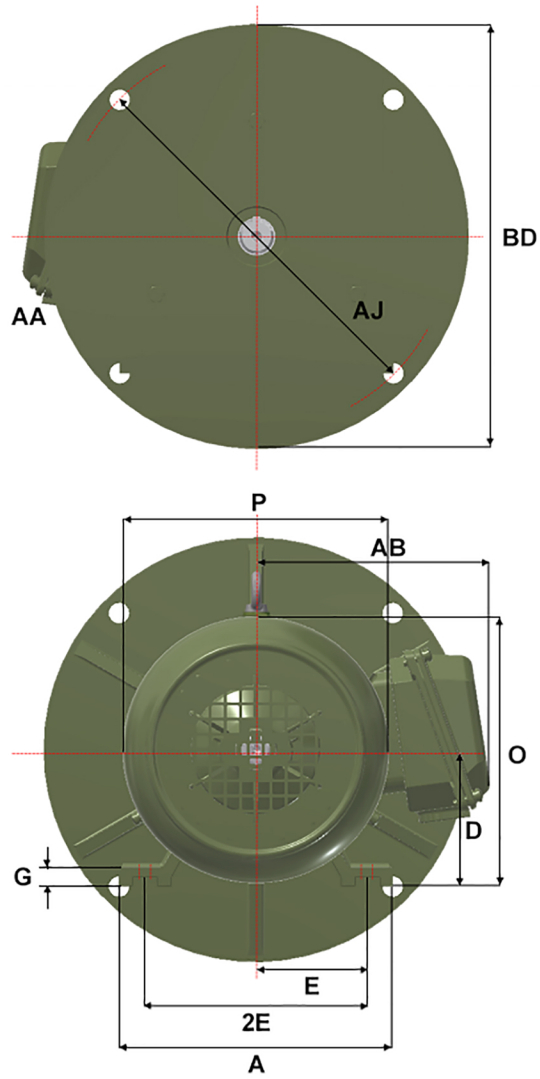

Version: 2WTI		Revised: 08-10-2019		HP	RPM	FRAME	ENCLOSURE	MPP/MQP-34D					
Customer is responsible in determining that MEP product will fit/perform suitably in the intended application				10	900	284TD	TEFC						
A	B	C	D	E	2E	2F	G	H	O	P	R	S	
14.00	13.20	26.60	7.00	5.50	11.00	9.50	0.85	4 * 0.53	14.50	14.00	1.591	0.500	
T	U	V	AA	AB	AH	AJ	AK	BA	BB	BC	BD	ES	
2.20	1.875	4.38	1-1/2 NPT	11.30	4.62	12.50	11.00	3.50	0.25	0.00	14.00	3.28	